

# M DRIVE 34™

MOTOR+DRIVER

## MICROSTEPPING



### FEATURES

- Integrated Microstepping Driver and NEMA 34 High Torque 1.8° Stepping Motor
- +24 to +75 VDC Input Voltage
- Low Cost
- Extremely Compact
- Optically Isolated Logic Inputs will Accept +5 to +24 VDC Signals, Sourcing or Sinking
- Automatic Current Reduction
- Configurable:
  - Motor Run/Hold Current
  - Motor Direction vs. Direction Input
  - Microstep Resolution to 256 Microsteps/Full Step
- Available Configurations:
  - Single Shaft\*
  - Long Life Linear Actuator
  - Internal Optical Encoder\*
  - Control Knob for Manual Positioning\*
  - Integrated Planetary Gearbox\*
- Three Stack Sizes Available\*
- Current and Resolution May Be Switched On-The-Fly
- Single Supply
- Interface Uses 12.0" (30.5cm) Flying Leads
- Graphical User Interface (GUI) for Quick and Easy Parameter Setup

\* Rotary Motor Only

### DESCRIPTION

The MDrive NEMA 34 high torque Integrated Motor and Driver is ideal for designers who want the simplicity of a motor with on-board electronics, but without the expense of an indexer on each axis. The low cost MDrive34 puts the system designer in the driver's seat to decide the best method of control. The MDrive34's integrated electronics eliminate the need to run the motor cabling through the machine, reducing the potential for problems due to electrical noise.

The MDrive34 uses a NEMA 34 frame size 1.8° high torque motor combined with a microstepping driver, and accepts up to 14 resolution settings from 1/2 to 256 microsteps per full step. Setup parameters include Microstep Resolution, Motor Run/Hold Current, and Motor Direction with respect to the direction input. These settings may be changed on-the-fly or downloaded and stored in nonvolatile memory with the use of a simple GUI which is provided. This eliminates the need for external switches or resistors. Parameters are changed via an SPI port. MDrive34 operating voltage ranges from +24 to +75 VDC.

The MDrive34 is available in multiple configurations to fit various system needs including a single shaft rotary motor with optional internal optical encoder, a dual shaft rotary motor with control knob, a planetary gearbox, or a long life Acme screw linear actuator. The rotary MDrive34 is available in single, double and triple stack sizes: 24, 31 & 47. Interface

connections are accomplished using 12.0" (30.5cm) flying leads.

The MDrive34 is a compact, powerful and inexpensive solution that will reduce system cost, design and assembly time for a large range of stepping motor applications.

### CONFIGURING

The IMS Motor Interface software is an easy to install and use GUI for configuring the MDrive34 from a computer parallel/SPI port. GUI access is via the IMS SPI Interface included on the CD shipped with the product, or download at [www.imshome.com](http://www.imshome.com). An optional cable is available for ease of connecting and configuring the MDrive.

The IMS Motor Interface features:

- Easy installation.
- Automatic detection of MDrive version and communication configuration.
- Will not set out-of-range values.
- Tool-tips display valid range setting for each option.
- Single screen interface (*below*).

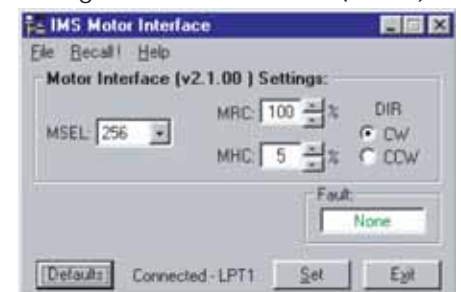

The IMS Motor Interface GUI simplifies MDrive configuring with a single screen interface.

# MDRIVE34 MICROSTEPPING SPECIFICATIONS

## GENERAL SPECIFICATIONS

Input Voltage (+V) Range*	+24 to +75 VDC
Isolated Inputs	Step Clock, Direction & Enable
Isolated Input Voltage Range (Sourcing or Sinking)	+5 to +24 VDC
Step Frequency (Max)	2 MHz
Steps per Revolution	400, 800, 1000, 1600, 2000, 3200, 5000, 6400, 10000, 12800, 25000, 25600, 50000, 51200
Heat Sink Temperature (Max)	85° C
Motor Temperature (Max)	100° C
Protection	Over Voltage

\*Power supply current requirements = 4A (maximum) per MDrive34.  
Actual power supply current will depend on voltage and load.

## PARAMETERS

SETUP PARAMETERS				
NAME	FUNCTION	RANGE	UNITS	DEFAULT
MHC	Motor Hold Current	0 to 100	percent	5
MRC	Motor Run Current	1 to 100	percent	25
MSEL	Microstep Resolution	2, 4, 5, 8, 10, 16, 25, 32, 50, 64, 125, 128, 250, 256	µsteps per step	256
DIR	Motor Direction Override	0 / 1	--	CW

All parameters are set using the supplied IMS Motor Interface GUI and may be changed on-the-fly.  
An optional Parameter Setup Cable is recommended with first orders.

## WIRE/PIN ASSIGNMENTS

CONNECTOR P1 – Flying Leads	
WIRE COLOR	FUNCTION
White	OPTOCOUPLER REFERENCE
Orange	STEP CLOCK INPUT
Blue	CW/CCW DIRECTION INPUT
Brown	ENABLE INPUT
Black	POWER GROUND
Red	+V (+24 TO +75 VDC)
CONNECTOR P2 (SPI) – 10 Pin Pin-Header	
PIN	FUNCTION
4	CHIP SELECT
5	GROUND
6	+5 VDC OUTPUT
7	MASTER OUT - SLAVE IN
8	CLOCK
10	MASTER IN - SLAVE OUT

## ENCODER WIRE ASSIGNMENTS

ENCODER – Single-End		ENCODER – Differential	
WIRE COLOR	FUNCTION	WIRE COLOR	FUNCTION
Yellow/Black	GROUND	Yellow/Black	GROUND
Yellow/Violet	INDEX	Yellow/Violet	INDEX +
Yellow/Blue	CHANNEL A	Yellow/Blue	CHANNEL A +
Yellow/Red	+5 VDC INPUT	Yellow/Red	+5 VDC INPUT
Yellow/Brown	CHANNEL B	Yellow/Brown	CHANNEL B +
		Yellow/Gray	INDEX –
		Yellow/Green	CHANNEL A –
		Yellow/Orange	CHANNEL B –

NOTE: For recommended mating connector information, refer to the product's Quick Reference at [www.imshome.com/quick.html](http://www.imshome.com/quick.html)

# MDRIVE34 MOTOR SPECIFICATIONS

## MD3424 Single Stack

Holding Torque ..... 381.0 oz-in / 269 N-cm  
 Detent Torque ..... 10.9 oz-in / 7.7 N-cm  
 Rotor Inertia ..... 0.01416 oz-in-sec<sup>2</sup> / 1.0 kg-cm<sup>2</sup>  
 Weight (Motor+Driver)..... 67.4 oz / 1909 g

## MD3447 Triple Stack

Holding Torque ..... 1061.0 oz-in / 749 N-cm  
 Detent Torque ..... 19.83 oz-in / 14.0 N-cm  
 Rotor Inertia ..... 0.04815 oz-in-sec<sup>2</sup> / 3.4 kg-cm<sup>2</sup>  
 Weight (Motor+Driver)..... 148.5 oz / 4209 g

## MD3431 Double Stack

Holding Torque ..... 575.0 oz-in / 406 N-cm  
 Detent Torque ..... 14.16 oz-in / 10.0 N-cm  
 Rotor Inertia ..... 0.02266 oz-in-sec<sup>2</sup> / 1.6 kg-cm<sup>2</sup>  
 Weight (Motor+Driver)..... 92.1 oz / 2609 g

## MD3429 Linear Actuator

Maximum Thrust ..... 500 lbs / 2224 N  
 Maximum Screw Deflection ..... ± 1°  
 Backlash ..... 0.005 in / 0.127 mm  
 Weight (without screw)..... 89.0 oz / 2523 g

## TORQUE-SPEED CURVES

### Rotary Motor

#### MD3424 Single Stack

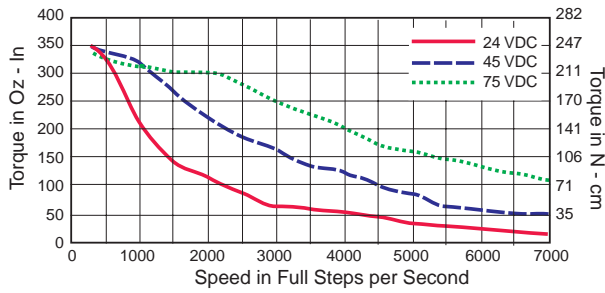

#### MD3431 Double Stack

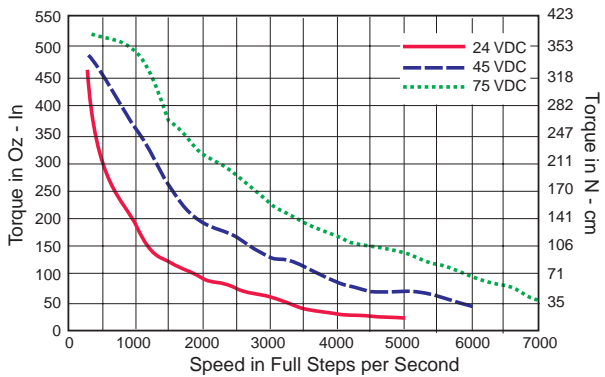

#### MD3447 Triple Stack

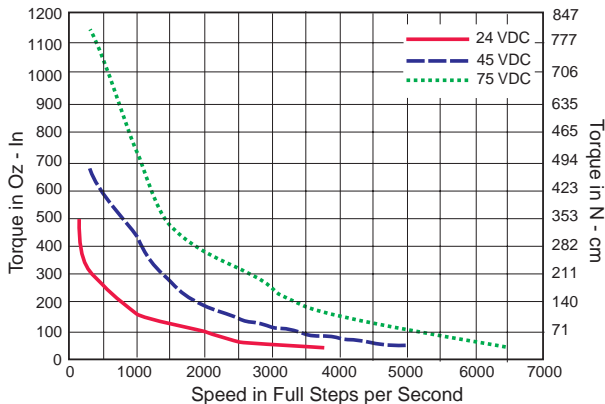

## FORCE-SPEED CURVES

### Linear Actuator

#### 24 VDC

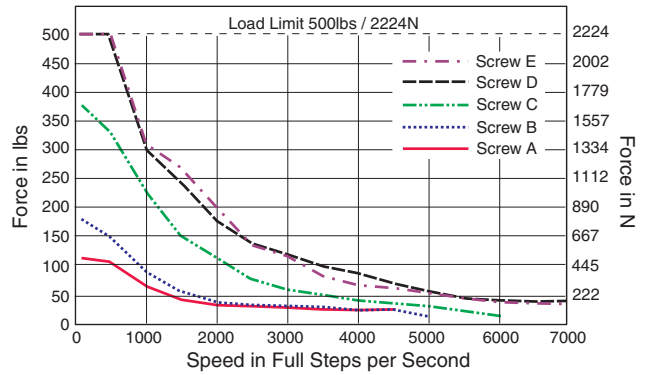

#### 48 VDC

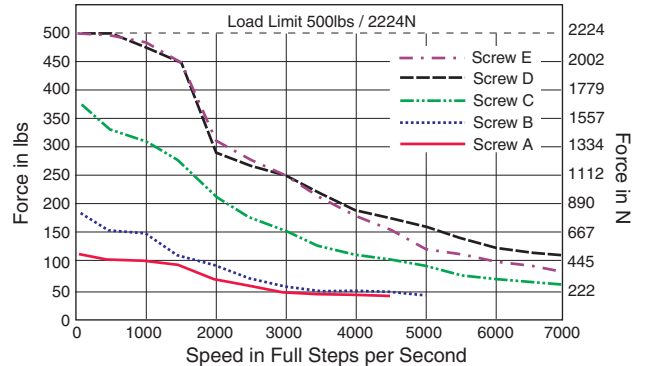

#### 75 VDC

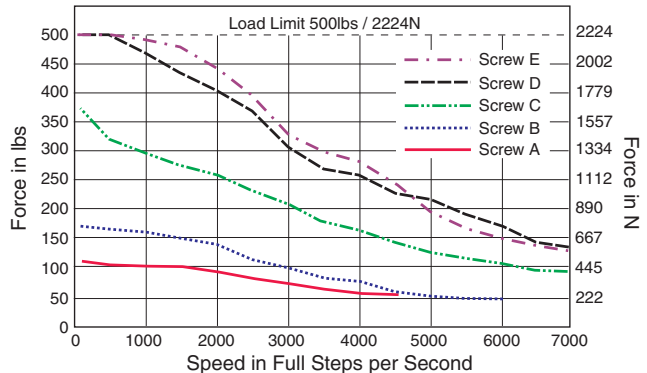

## MDRIVE34 WITH PLANETARY GEARBOX

The MDrive34 is available with a Planetary Gearbox option developed to increase torque at lower speeds, enable better inertia matching and produce finer positional resolutions. These efficient, low maintenance Planetary Gearbox come fully assembled with the MDrive and are offered in a large number of

reduction ratios in 1-, 2- and 3-stage configurations. An optional NEMA Flange allows mounting the Planetary Gearbox to the load using a standard NEMA bolt circle. Planetary Gearbox may be combined with other MDrive34 options, however are unavailable on Linear Actuator versions.

### Parameters

	1-Stage	2-Stage	3-Stage
Permitted Output Torque (oz-in/Nm)	2832/20.0	8496/60.0	16992/120.0
Gearbox Efficiency	0.80	0.75	0.70
Maximum Backlash (degree)	1.0°	1.5°	2.0°

### Output Side With Ball Bearing

Maximum Load, Radial (lb-force/N)	90/400	135/600	225/1000
Maximum Load, Axial (lb-force/N)	18/80	27/120	45/200
Weight - Gearbox Only (oz/g)	64.4/1827	89.5/2538	114.6/3248
Weight - Gearbox & NEMA Flange (oz/g)	66.7/1890	92.6/2625	118.5/3360

## PLANETARY GEARBOX MECHANICAL SPECIFICATIONS

Dimensions in Inches (mm)

### Planetary Gearbox for MDrive34

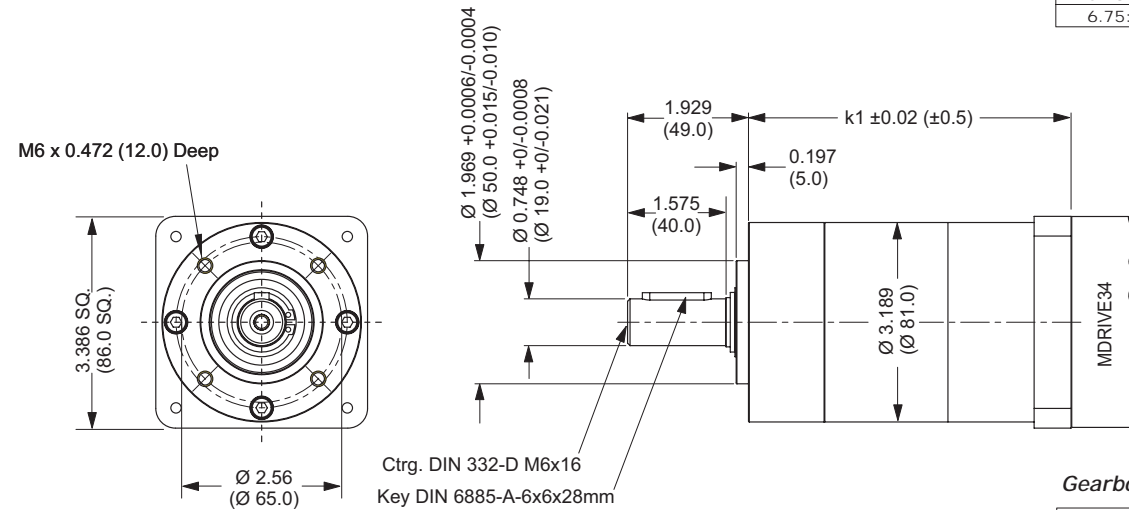

### Gearbox Ratios (Rounded)

1-Stage	2-Stage	3-Stage
3.70:1	13.73:1	50.89:1
5.18:1	15.88:1	58.85:1
6.75:1	18.36:1	68.06:1
	19.20:1	71.16:1
	22.20:1	78.71:1
	25.01:1	92.70:1
	26.85:1	95.17:1
	28.93:1	99.50:1
	34.97:1	107.20:1
	45.56:1	115.07:1
		123.97:1
		129.62:1
		139.13:1
		149.90:1
		168.84:1
		181.24:1
		195.26:1
		236.09:1
		307.54:1

### Planetary Gearbox with Optional NEMA Output Flange

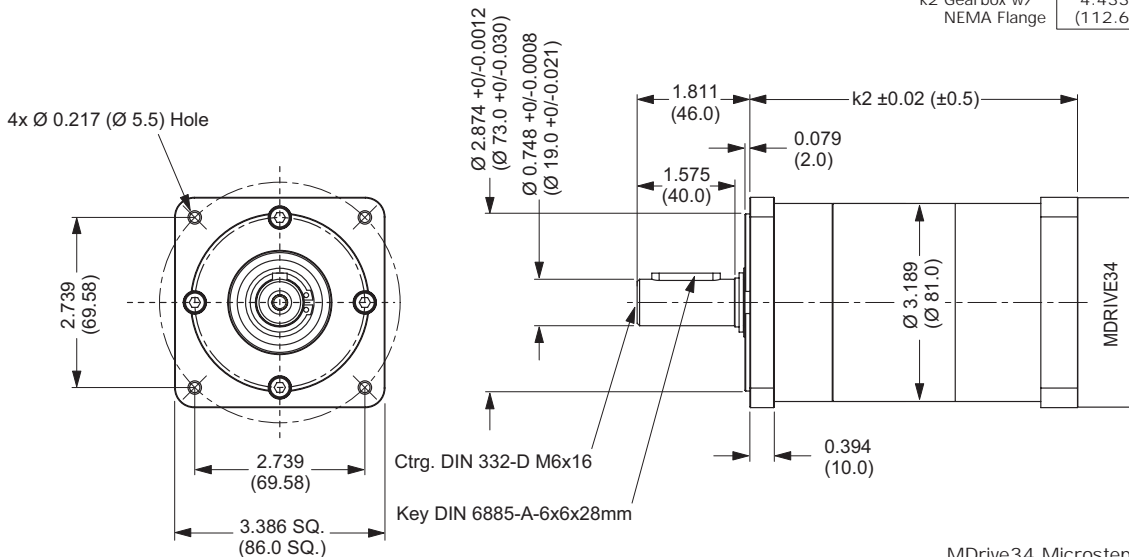

### Gearbox Lengths Inches (mm)

	1-Stage	2-Stage	3-Stage
k1 Gearbox	4.315 (109.6)	5.169 (131.3)	6.024 (153.0)
k2 Gearbox w/ NEMA Flange	4.433 (112.6)	5.287 (134.3)	6.142 (156.0)

# MDRIVE34 MICROSTEPPING – MECHANICAL SPECIFICATIONS

Dimensions in Inches (mm)

## Rotary MDrive34: Single Shaft, Control Knob & Encoder Versions

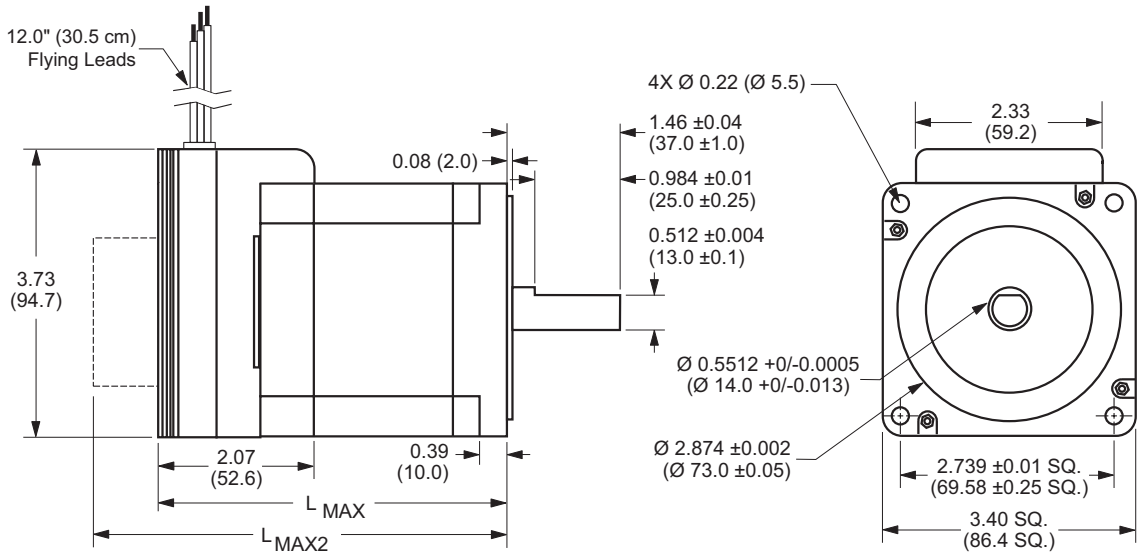

### MDrive Lengths Inches (mm)

Stack Size	L <sub>MAX</sub>	L <sub>MAX2</sub>
	SINGLE SHAFT or ENCODER VERSION	CONTROL KNOB VERSION
3424	3.81 (96.8)	4.97 (126.2)
3431	4.60 (116.8)	5.76 (146.3)
3447	6.17 (156.7)	7.34 (186.4)

L<sub>MAX2</sub> - Control Knob

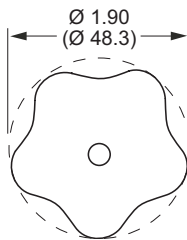

### MDrive34 Top View

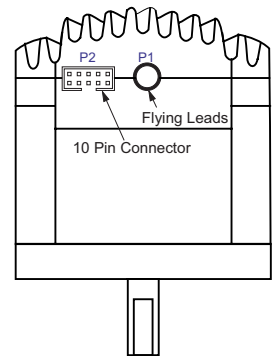

## Linear Actuator MDrive34

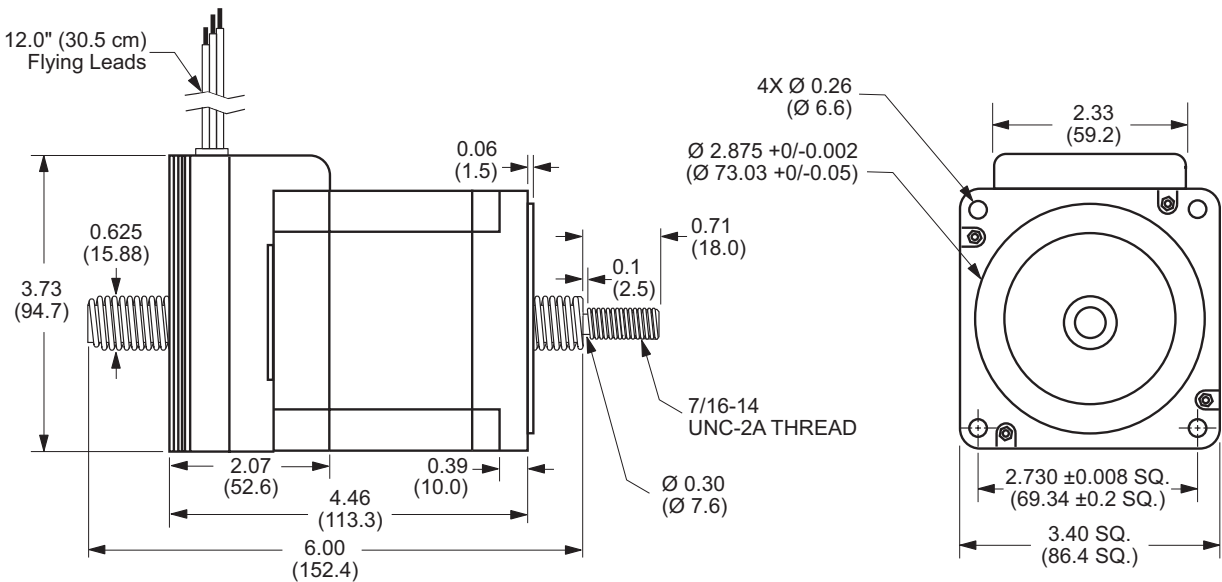

## MDRIVE34 MICROSTEPPING – OPTIONS

### Control Knob

The MDrive34 is available with a factory-mounted rear control knob for manual shaft positioning.

### Planetary Gearbox

Efficient, low maintenance Planetary Gearbox are offered assembled with the MDrive34. Details inside.

### Encoder

The MDrive34 is available with a factory-mounted internal optical encoder. Available line counts are 100, 200, 250, 400, 500 or 1000. All encoders, except the 1000 line, have an index mark. Encoders are available in both single-end and differential configurations.

### Linear Actuator

The MDrive34 with long life Acme Screw Linear Actuator is available with the following travel/full step:

Screw A	0.005"/full step
Screw B	0.0025"/full step
Screw C	0.00125"/full step
Screw D	0.000625"/full step
Screw E	0.0005"/full step

Standard screw length is 6.0" (152.4mm) plus the mounting end thread. Custom lengths up to 24.0" are available without mounting end thread.



Linear Actuators are Non-Captive style. Contact the factory regarding Captive Shaft or External styles.

### Parameter Setup Cable

A low cost accessory which eliminates the need for users to wire communications. This 6' (1.8m) cable includes built-in logic level shifting circuitry to accommodate the 3.3v ports on some PCs and plugs in easily to connect a standard DB-25 PC parallel/SPI port to the MDrive's 10 pin pin-header (P2). Order Cable Part No. MD-CC100-000.

## ORDER INFORMATION

MDRIVE34 MICROSTEPPING	
<p>Stack Sizes</p> <p>24 = Single Stack</p> <p>29 = Linear Actuator †</p> <p>31 = Double Stack</p> <p>47 = Triple Stack</p>	
<p><b>Example #1:</b> Part Number <b>MDMF3431</b> is an MDrive34 Microstepping with Flying Leads, NEMA 34 motor, stack size 31.</p>	

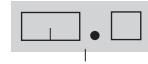
OPTIONS		
Control Knob	<b>N</b>	<b>Example #2: MDMF3431N</b> Adds a Control Knob to the part shown in example #1.
Planetary Gearbox	<b>G</b>  Gearbox Ratio Rounded to Nearest Whole Number	<b>Example #3: MDMF3431G5</b> Rounding ratio to the nearest whole number, the above adds a Planetary Gearbox with 5.18:1 ratio to the part shown in example #1. Add -F if optional NEMA Flange is desired.
Internal Encoder	<b>E</b>  S = Single End      Line Count D = Differential      100, 200, 250, 400, 500, 1000	<b>Example #4: MDMF3431ED500</b> Adds a 500 line count internal Differential Encoder to the part shown in example #1.
Linear Actuator †	<b>L</b>  Screw Type (Travel/Full Step)      Custom Screw Length A = 0.005"      Range 2.0" to 24.0" B = 0.0025"      Format XX.X C = 0.00125"      eg. 08.5 for an 8.5" Screw D = 0.000625"      (6.0" Screw Length Standard) E = 0.0005"	<b>Example #5: MDMF3429LA10.5</b> MDrive34 Microstepping Linear Actuator with a 0.005"/Full Step Acme Screw custom cut to 10.5". MAY NOT be combined with other options. <i>Note: MDrive34 Linear Actuator Available ONLY in Stack Size 29</i>

†Stack Size 29 is only available as a Linear Actuator and is the **ONLY** size Linear Actuator offered. (MDMF3429LX)



P.O. Box 457, 370 N. Main Street  
Marlborough, CT 06447 U.S.A.

Phone: 860/295-6102  
Fax: 860/295-6107  
E-mail: info@imshome.com  
Home Page: www.imshome.com

Distributed By:

### TECHNICAL SUPPORT

**Eastern U.S.**  
Phone: 860/295-6102  
Fax: 860/295-6107  
E-mail: etech@imshome.com

**Western U.S.**  
Phone: 760/966-3162  
Fax: 760/966-3165  
E-mail: wtech@imshome.com

### IMS MOTORS DIVISION

105 Copperwood Way, Suite H  
Oceanside, CA 92054  
Phone: 760/966-3162  
Fax: 760/966-3165  
E-mail: motors@imshome.com

### IMS EUROPE GmbH

Hahnstrasse 10, VS-Schwenningen  
Germany D-78054  
Phone: +49/7720/94138-0  
Fax: +49/7720/94138-2  
E-mail: info@imseuropehome.com

**European Sales Management**  
4 Quai Des Etoits  
69005 Lyon, France  
Phone: +33/4 7256 5113  
Fax: +33/4 7838 1537  
E-mail: bmartinez@imshome.com

**German Sales/Technical Support**  
Phone: +49/35205/4587-8  
Fax: +49/35205/4587-9  
E-mail: hruhland@imshome.com

Product information covered by IMS Product Disclaimer available at www.imshome.com. Visit the IMS web site for the most up-to-date product information.

© 2002, 2004 Intelligent Motion Systems, Inc. All Rights Reserved.

REV121704